

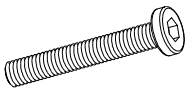

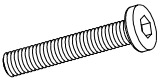

<p>A x 8</p>  <p>M6 x 50 mm</p>	<p>B x 38</p>  <p>M6 x 40 mm</p>	<p>C x 16</p>  <p>M6 x 30 mm</p>	<p>D x 20</p>  <p>M6 x 12 mm</p>	<p>E x 1</p>  <p>4 mm</p>
--	---	---	---	--

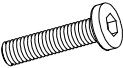

1

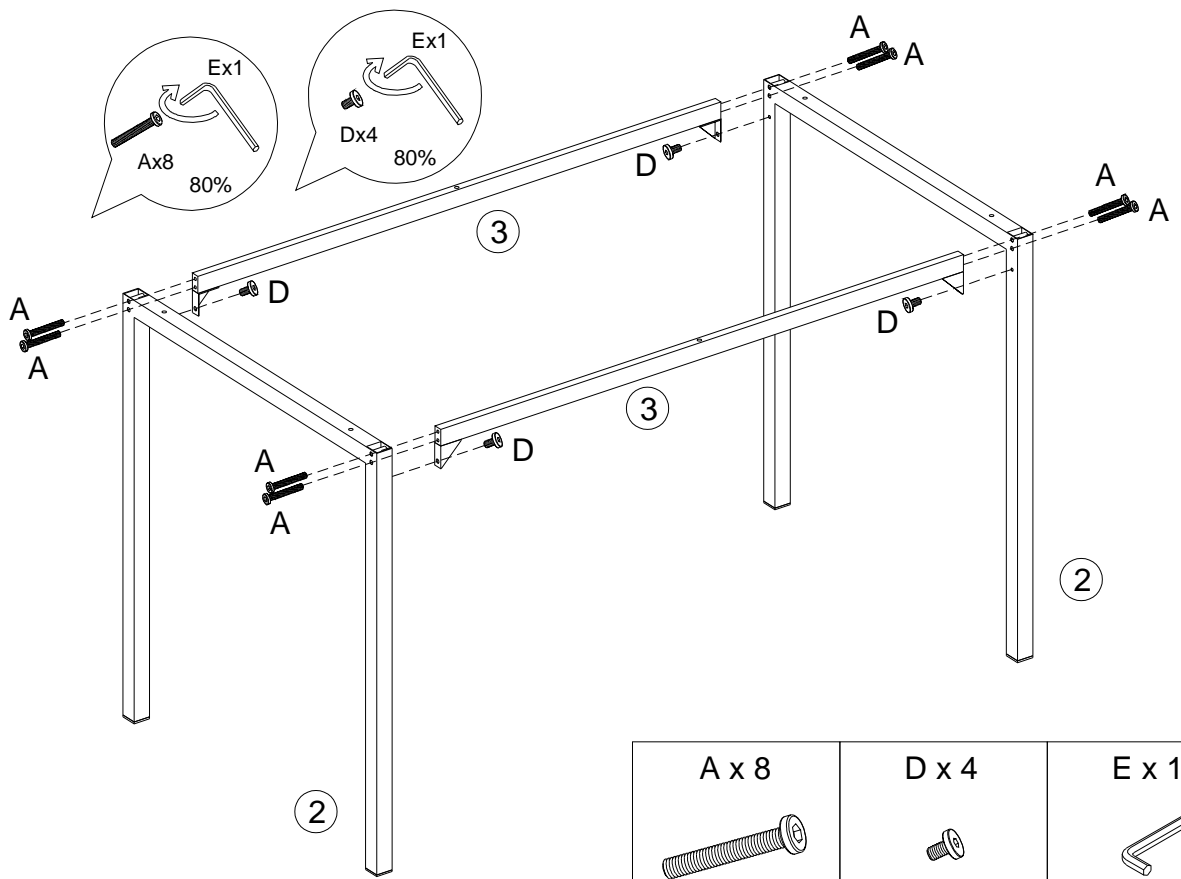
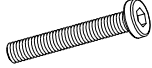

A x 8	D x 4	E x 1
		
M6 x 50 mm	M6 x 12 mm	4 mm

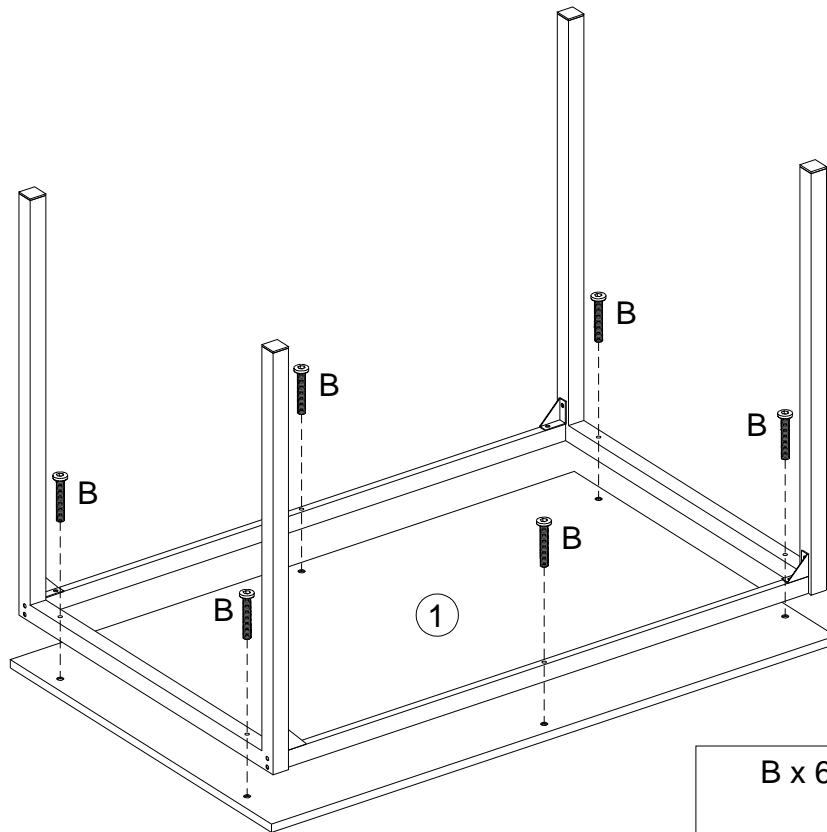

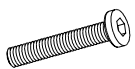
2



B x 6	E x 1
	
M6 x 40 mm	4 mm

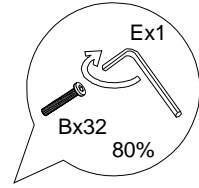
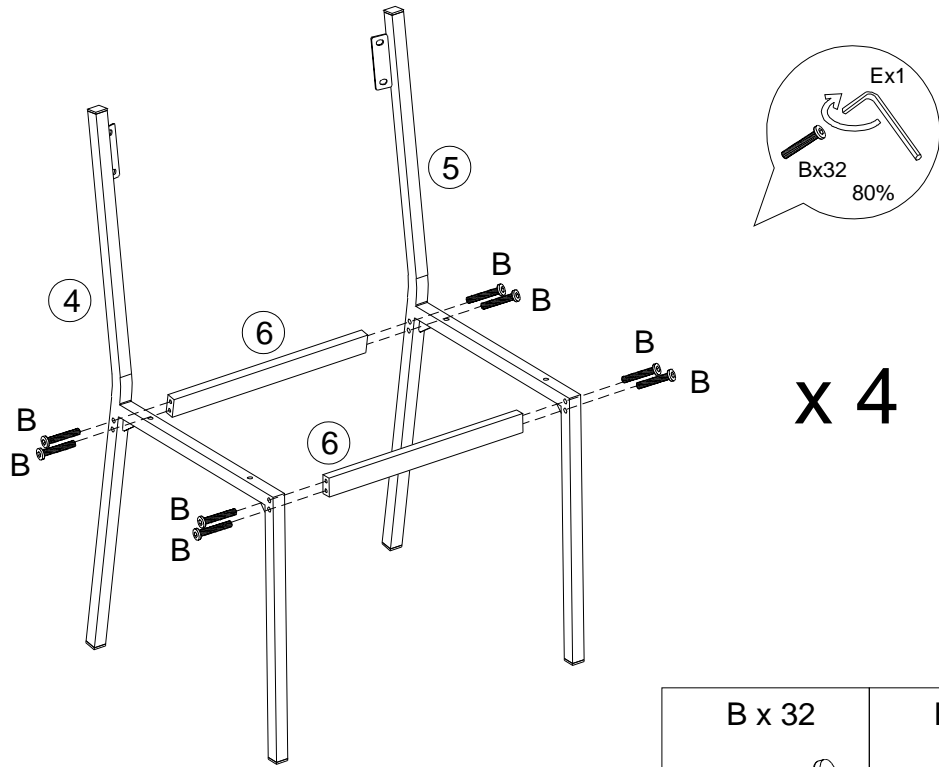

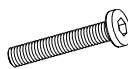
3

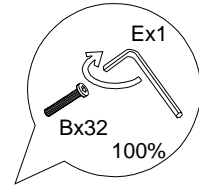
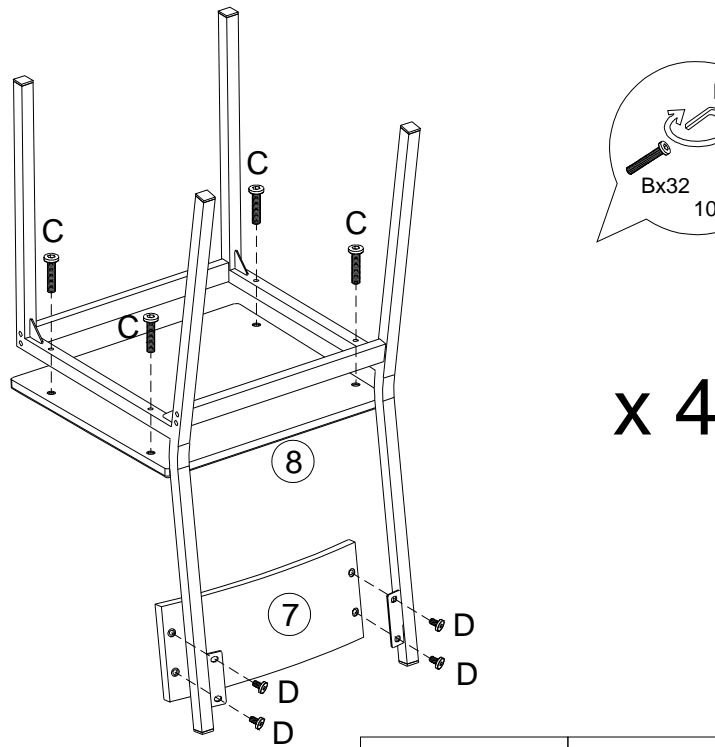

B x 32	E x 1
	
M6 x 40 mm	4 mm

4



C x 16	D x 16	E x 1
		
M6 x 30 mm	M6 x 12 mm	4 mm