

**STINNA**  
**BUF51**

**happy garden**

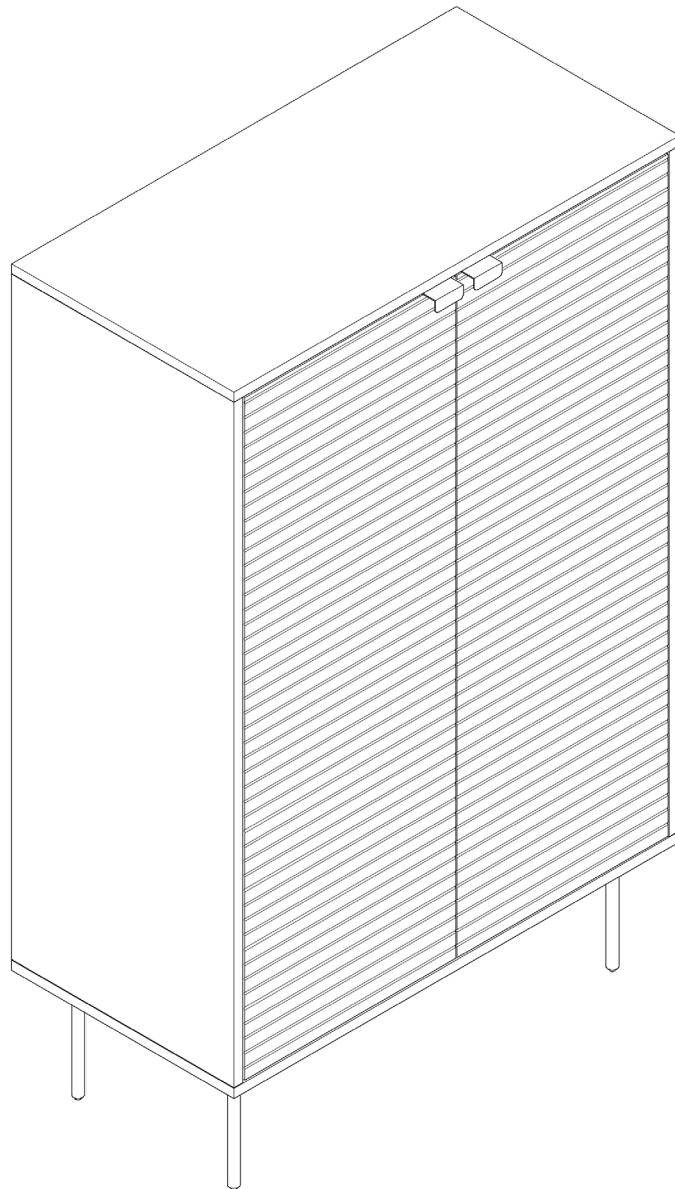

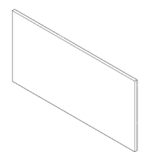

**1** x1

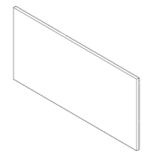

**2** x1



**3** x1

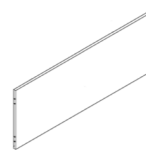

**4** x1

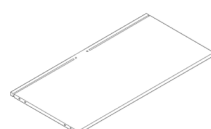

**5** x1



**6** x2

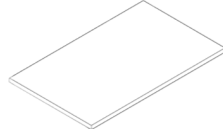

**7** x4



**8** x2



**9** x1



**10** x1

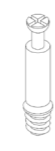

**A** x20



**B** x12

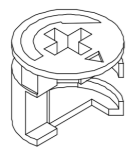

**C** x20



**D** x20



**E** x16

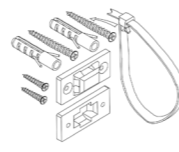

**F** x1

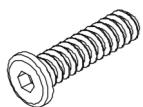

**G** x16



**H** x1

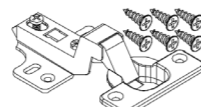

**I3** x6

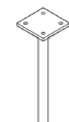

**J** x4

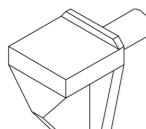

**L** x8

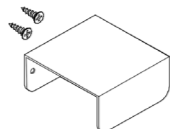

**U** x2



**Z1** x16



**Z2** x16

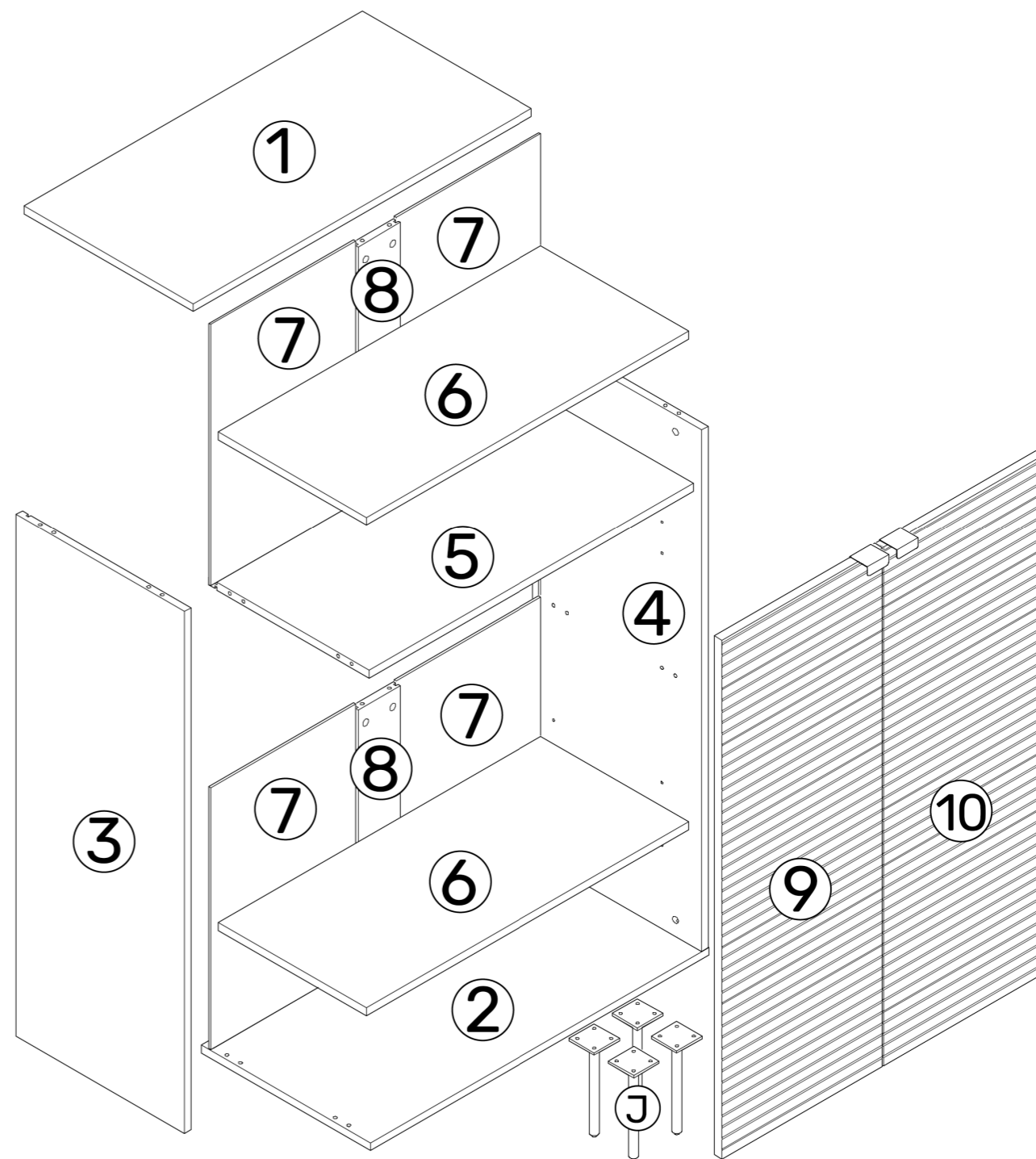

1

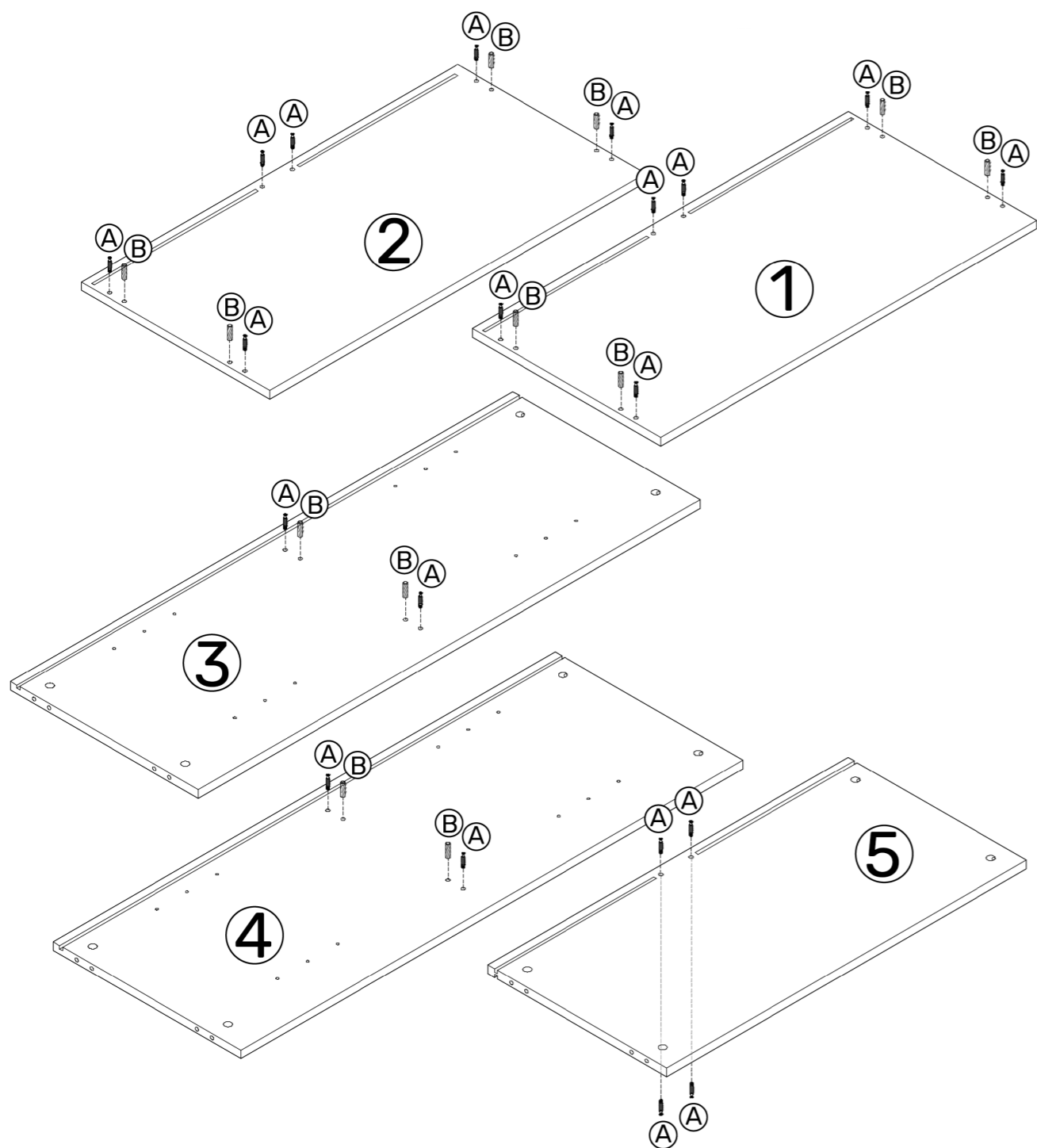

2

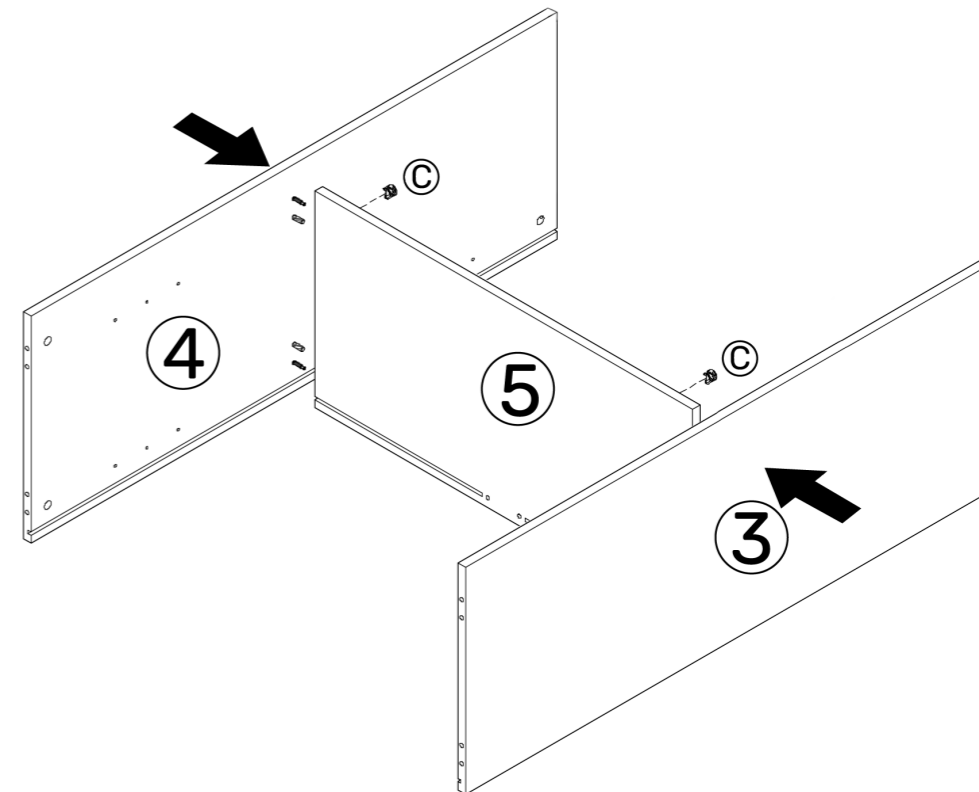

3

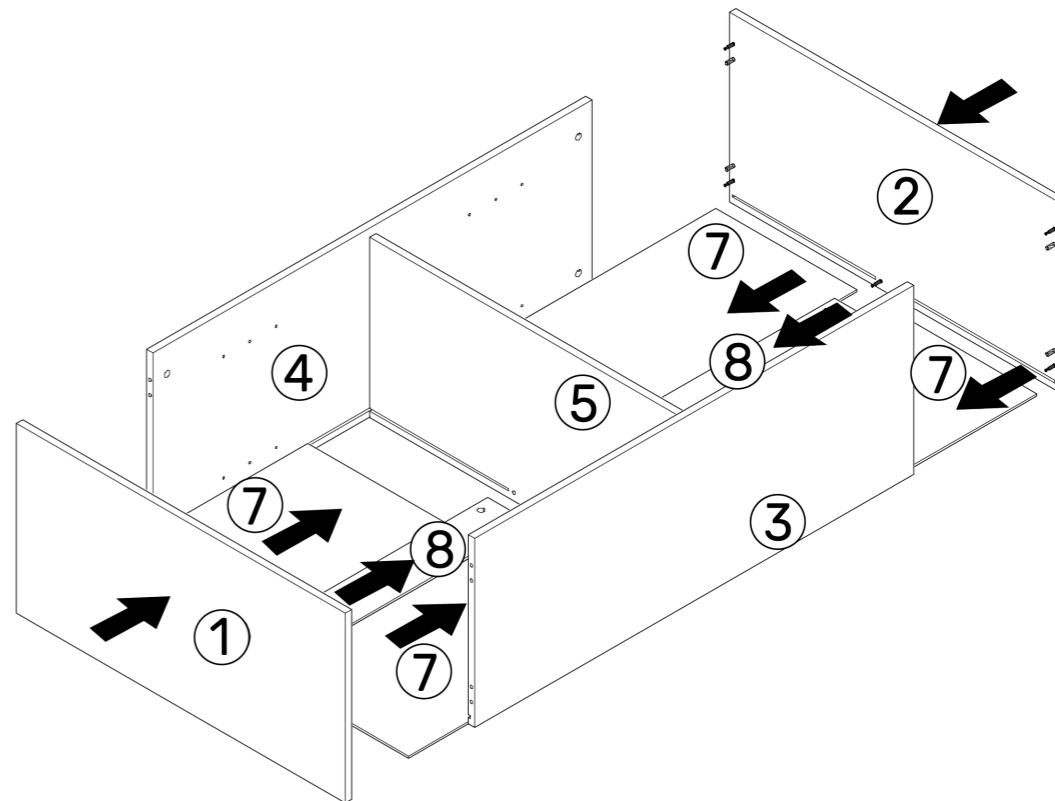

4

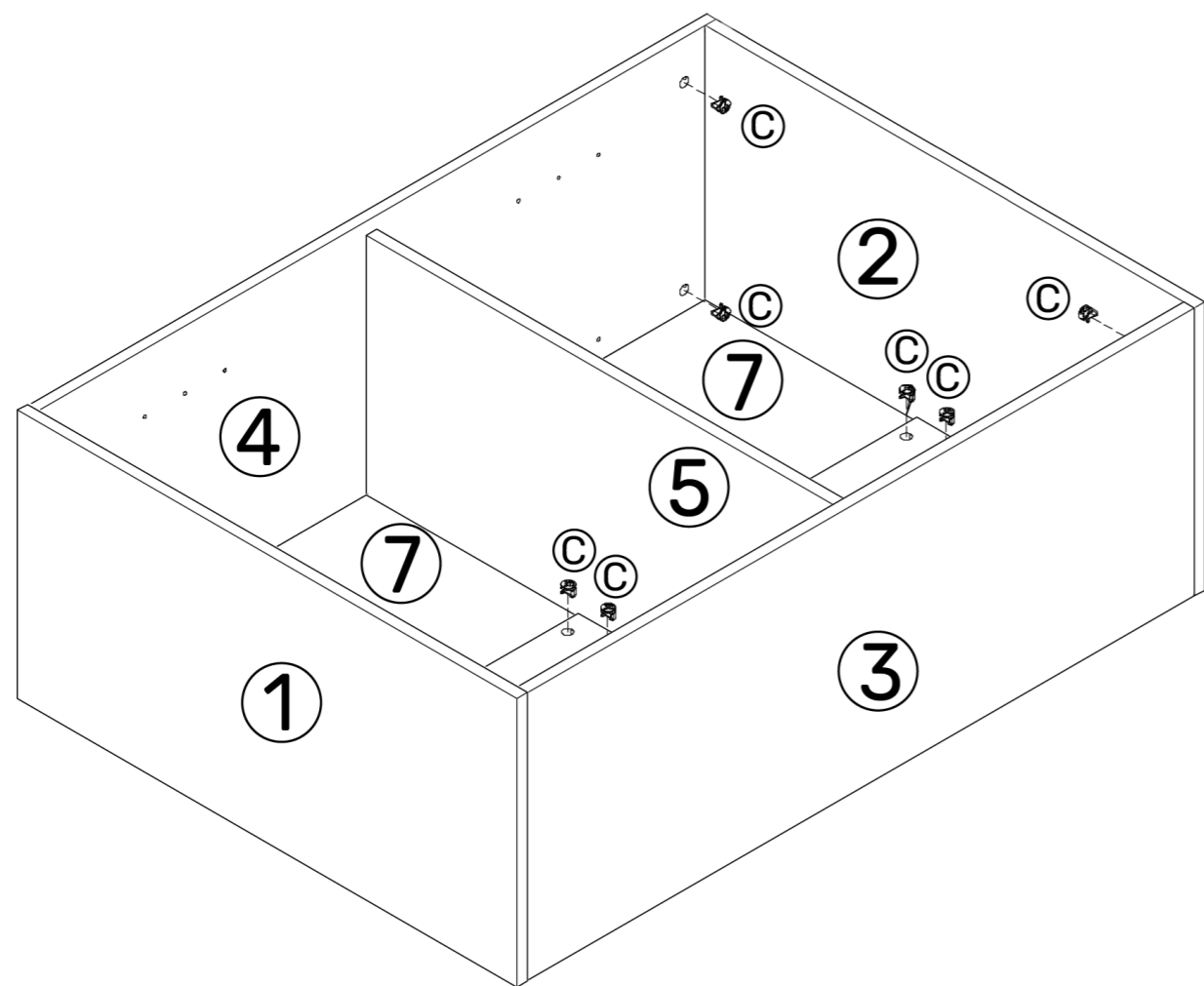

5

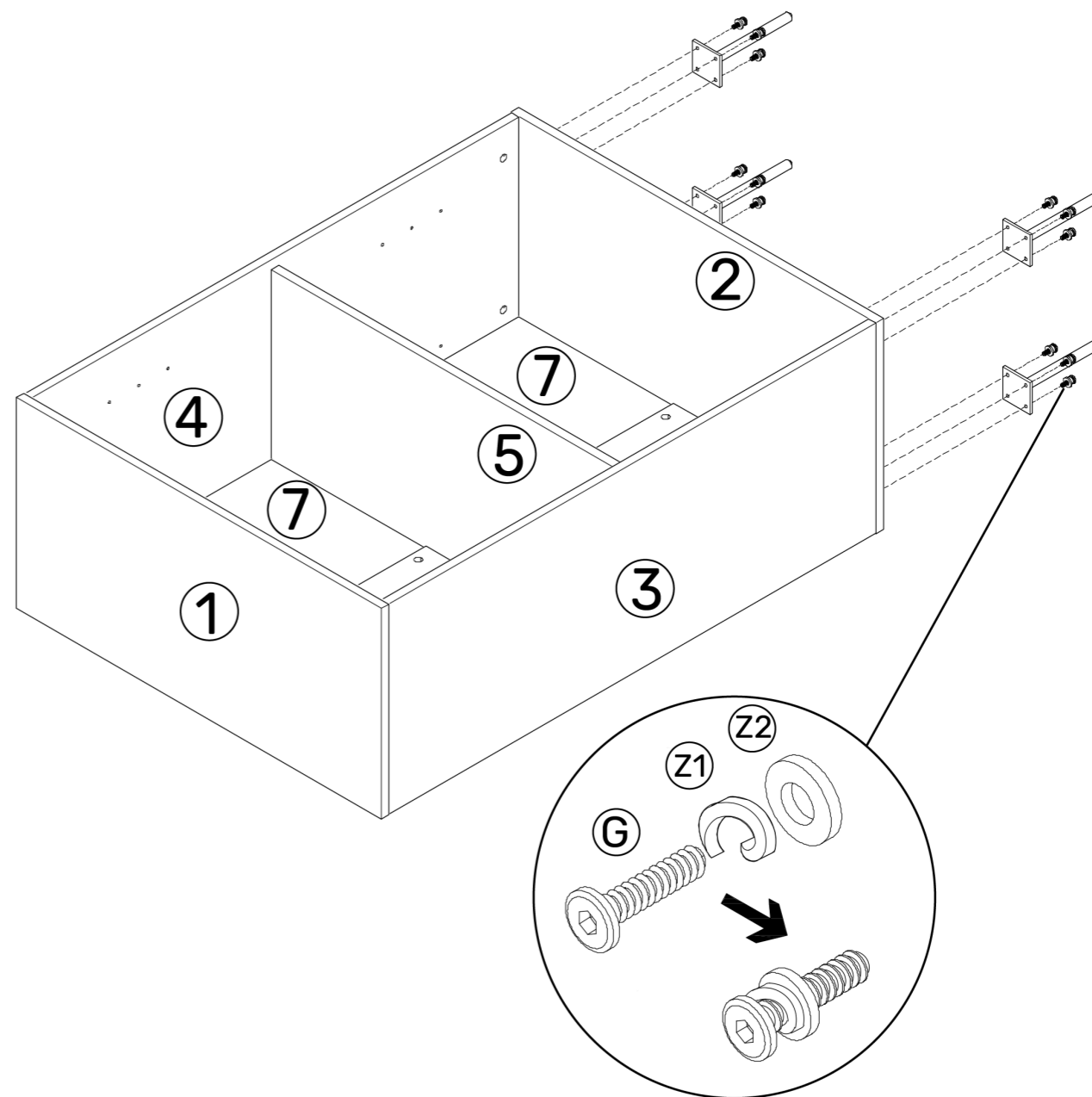

6

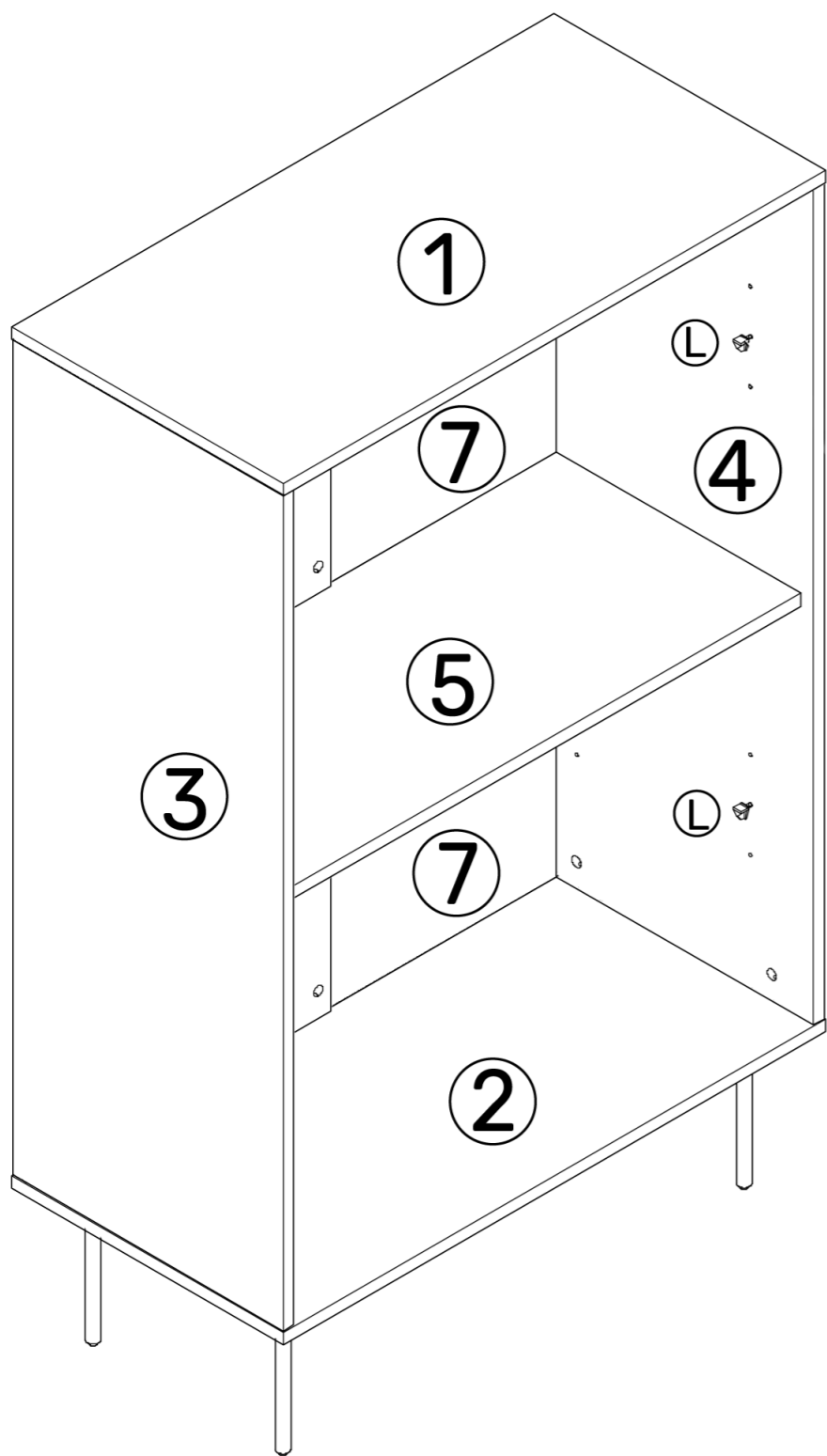

7

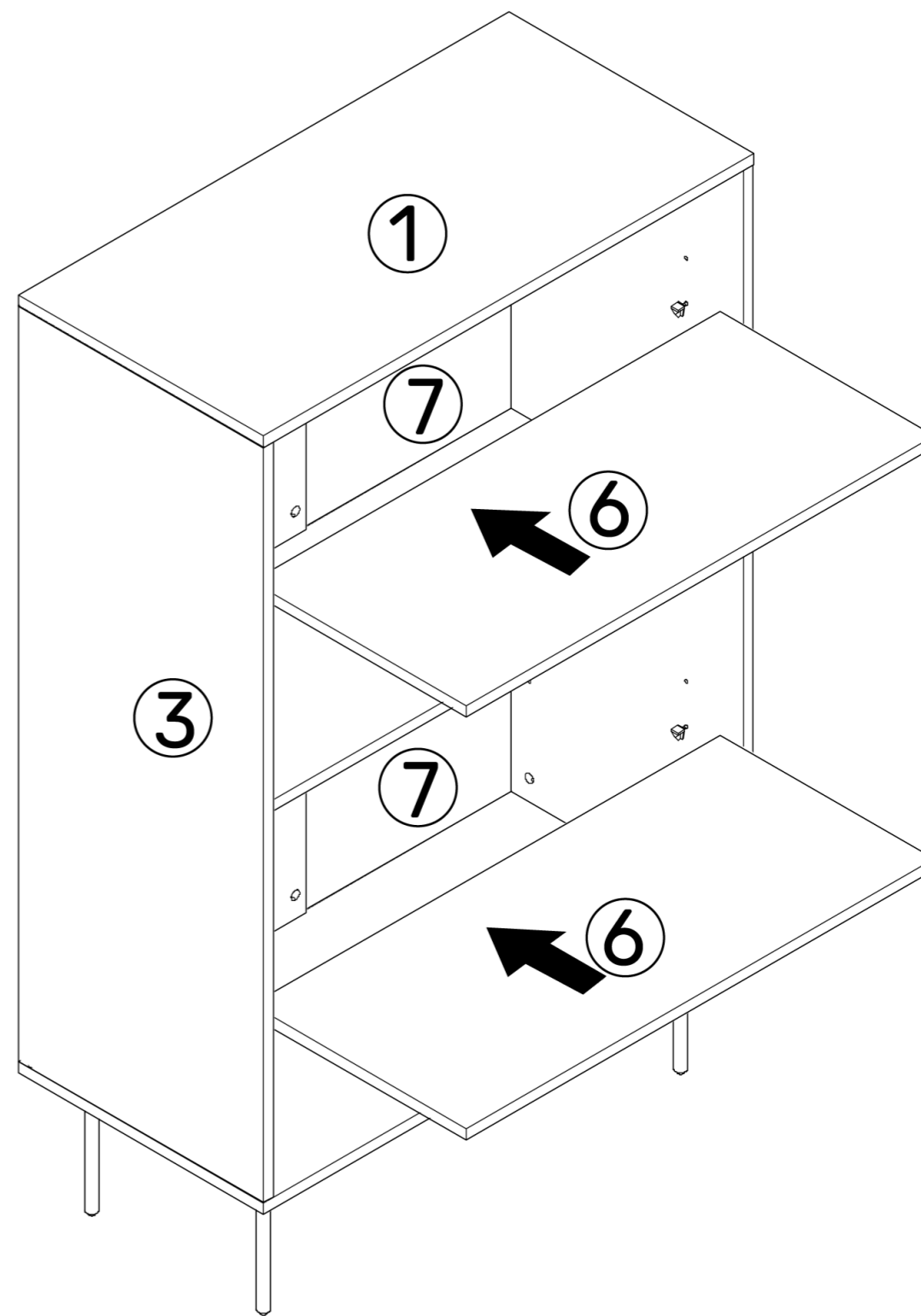

8

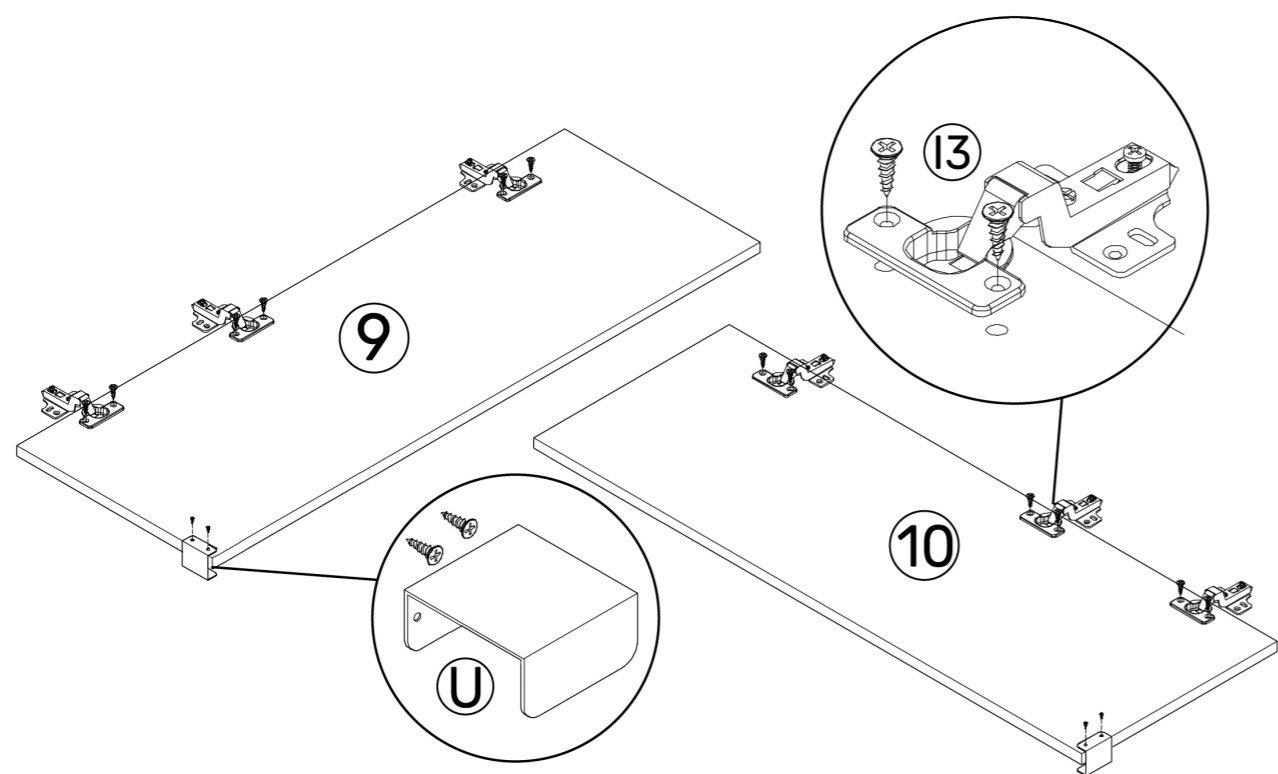

9

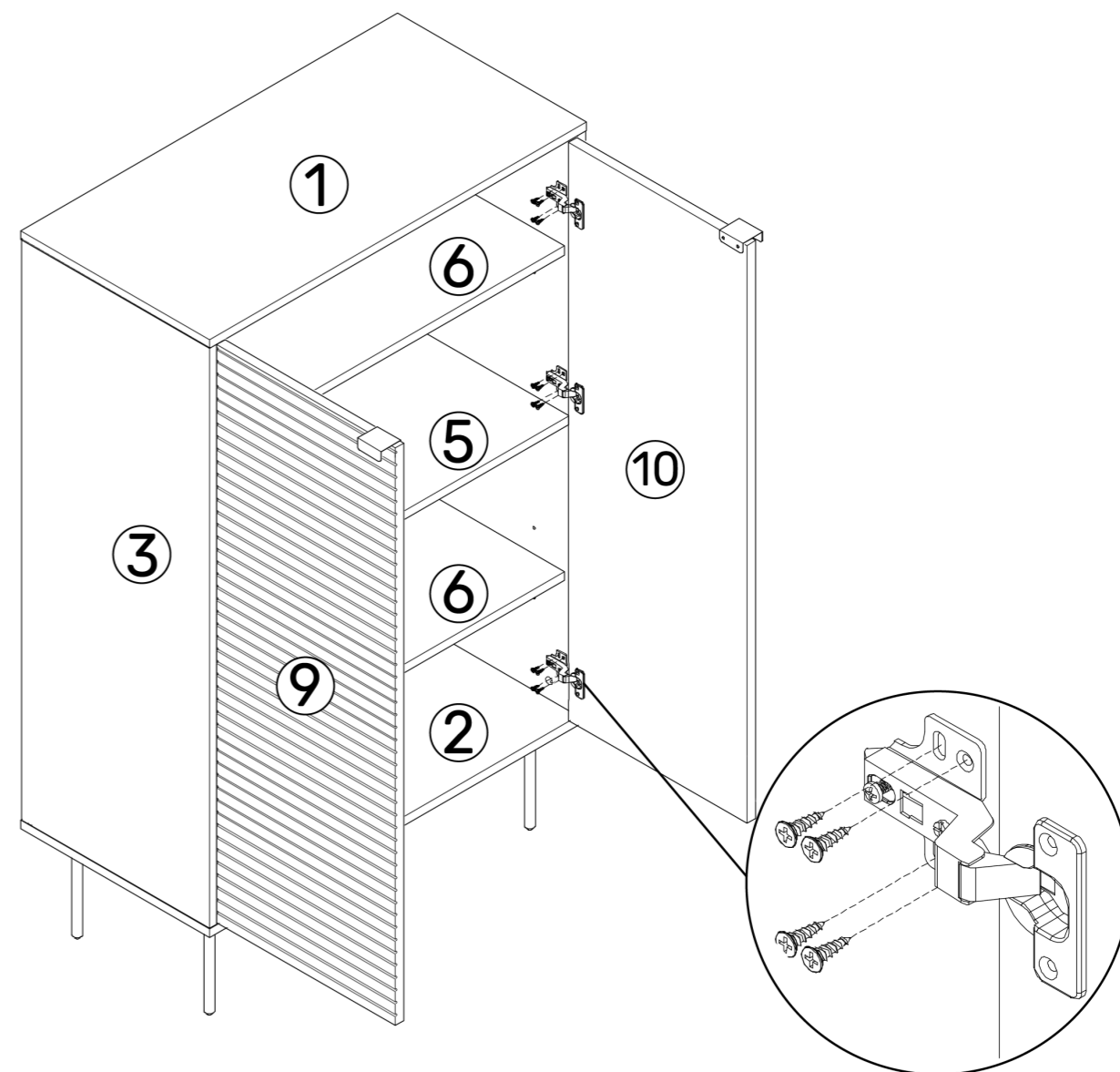

10

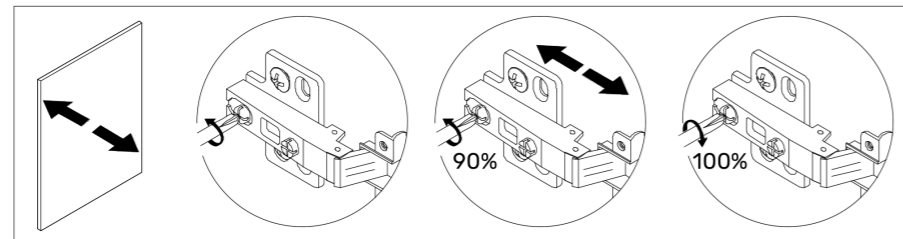
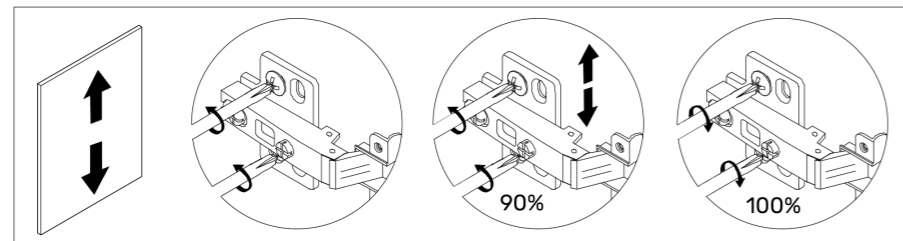
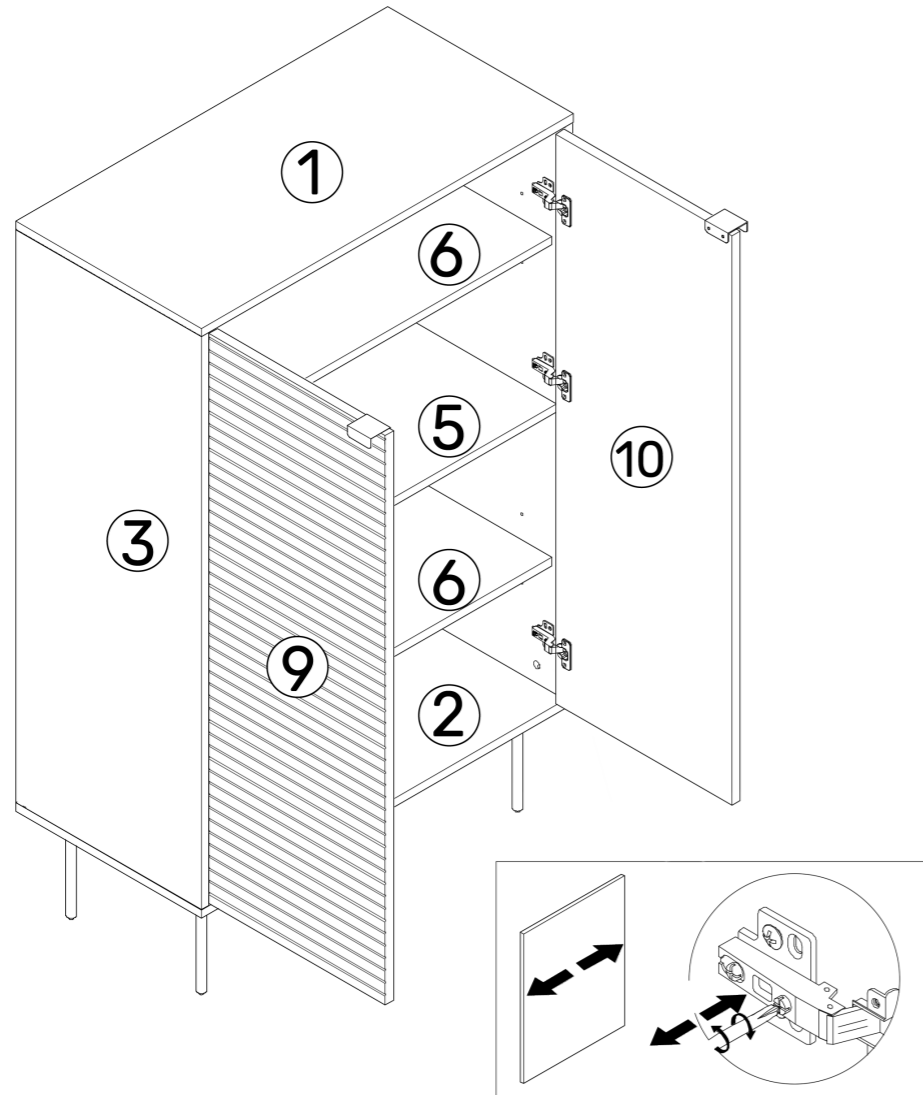

11

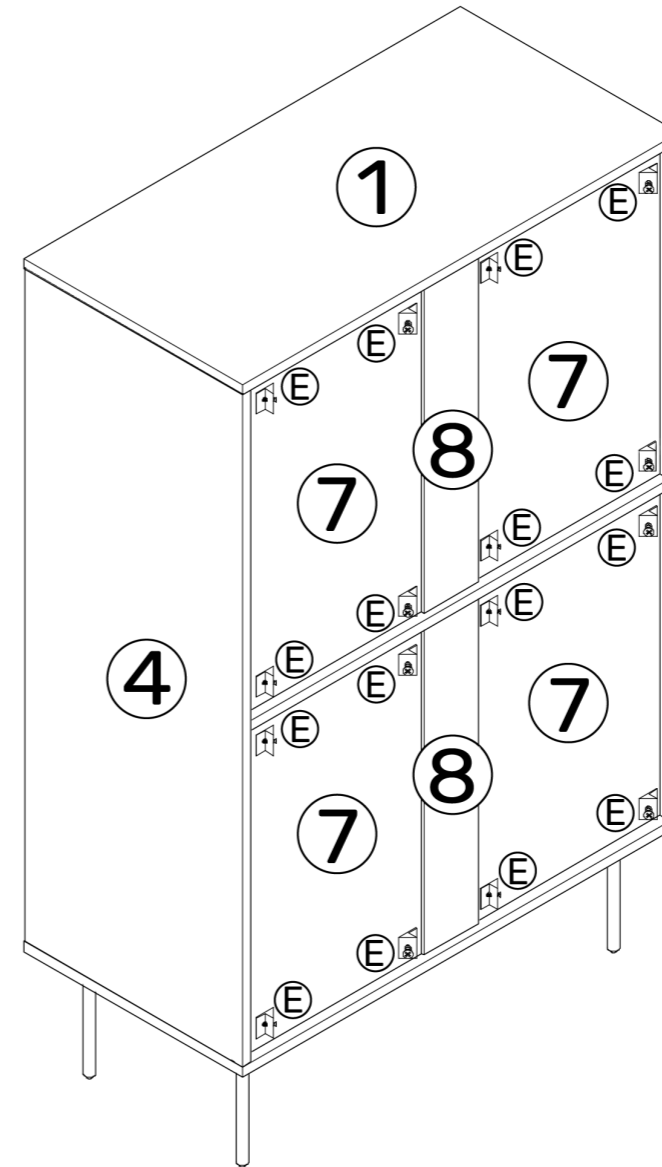

- FR** A la fin du montage, ajoutez les caches vis.
- ES** Al final del montaje, añade las tapas de los tornillos.
- EN** At the end of the assembly, add the screw covers.
- DE** Bringen Sie am Ende der Montage die Schraubenabdeckungen an.
- NL** Voeg aan het einde van de assemblage de schroefafdekkingen toe.
- IT** Alla fine dell'assemblaggio, aggiunga le coperture delle viti.

12

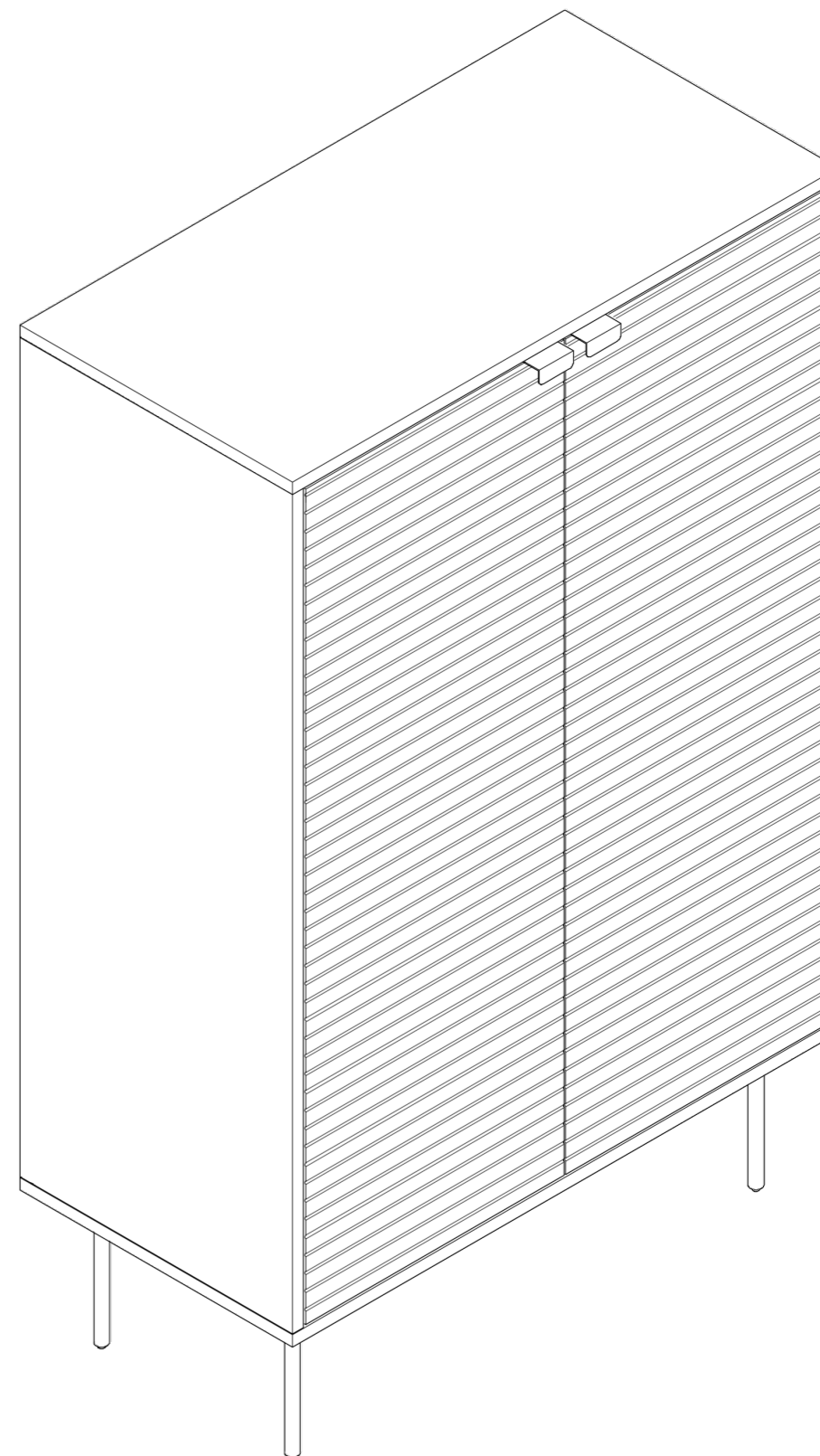
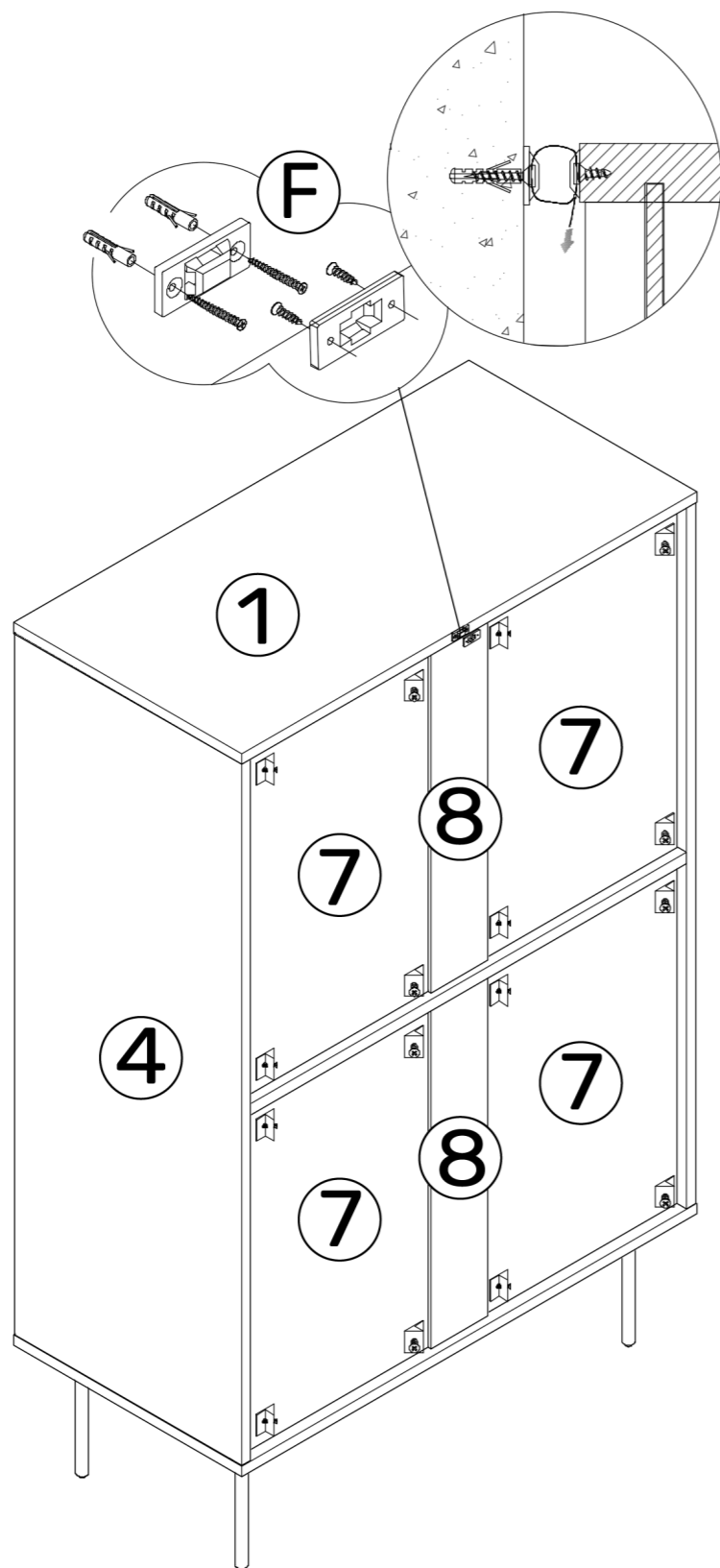





- FR** Veuillez conserver ce manuel pour référence ultérieure.  
En cas de problème avec votre produit, nous vous invitons à contacter notre service client par mail à [contact@happygarden.fr](mailto:contact@happygarden.fr) ou par téléphone au +33.3.20.267.567
- ES** Le rogamos conserve este manual de instrucciones para futuras consultas Si encuentra algún problema con su producto, le solicitamos que contacte con nuestro servicio de atención al cliente por correo electrónico: [spv@happy-garden.es](mailto:spv@happy-garden.es) o por teléfono al 919 035 926
- EN** Please keep this manual for future reference.  
If you have any problems with your product, please contact our customer service department by email at [contact@happygarden.fr](mailto:contact@happygarden.fr)
- DE** Bitte bewahren Sie diese Anleitung zum späteren Nachschlagen auf.  
Falls Sie ein Problem mit Ihrem Produkt haben, wenden Sie sich bitte an unseren Kundenservice per E-Mail an [contact@happygarden.fr](mailto:contact@happygarden.fr) oder telefonisch unter 0800.181.5780
- NL** Bewaar deze handleiding voor toekomstig gebruik.  
Indien u problemen heeft met uw product, neem dan contact op met onze klantendienst via e-mail op [contact@happygarden.fr](mailto:contact@happygarden.fr) of per telefoon op +31.85.208.4162
- IT** Si prega di conservare questo manuale per riferimento futuro.  
In caso di problemi con il prodotto, si prega di contattare il nostro servizio clienti via e-mail a [contact@happygarden.fr](mailto:contact@happygarden.fr) o per telefono al 800 58 02 30
- PT** Por favor, guarde este manual para referência futura.  
Se tiver algum problema com o seu produto, contacte por favor o nosso departamento de serviço ao cliente através do e-mail [contact@happygarden.fr](mailto:contact@happygarden.fr)

**happy garden**

Le jardin, ma pièce préférée



ALLSTORE SAS  
121 allée Hélène Boucher  
PA du Moulin  
59118 WAMBRECHIES  
FRANCE